

Service
Service
Service

Goedgekeurd

33 578A

Goedgekeurd

Service Manual

SPECIFICATIONS

Amplifier

Rated output voltage	: 1 V at 1000 Ω
Distortion	
THD	: 0.004% at 1 V for 1 kHz
IM	: 0.01% at 1 V
Frequency response	
Phono inputs	: 30-20.000 Hz, \pm 1 dB
Other inputs	: 20-20.000 Hz, \pm 0.8 dB
S/N ratio	
Phono inputs	: 75 dB weighted
Other inputs	: 92 dB weighted
Stereo separation	: 50 dB at 1 kHz 40 dB at 250-10.000 Hz
Phono overload	: 160 mV (at 1 kHz, D= 0.3%)

Controls

Bass	: +12 to -12 dB at 40 Hz
Treble	: +12 to -12 dB at 20 kHz
Loudness	: +9 dB at 40 Hz; +5 dB at 10 kHz
High filter	: 6 dB/octave, -3 dB at 6 kHz
Low filter	: 6 dB/octave, -3 dB at 200 Hz
Audio mute	: -20 dB
Balance control	: 0-50 dB

Inputs (for 1 V output at 1 kHz)

Phono MD	: 2.5 mV at 47 k Ω
Tape 1 and 2	: 150 mV at 47 k Ω
Compact Disc	: 150 mV at 47 k Ω
TV/Aux	: 150 mV at 47 k Ω
Tuner	: 150 mV at 47 k Ω

Outputs

Tape 1 and 2	: 150 mV at 2.5 k Ω
Line	: 1 V at 1 k Ω
Headphone	: 8-1000 Ω

Power supply

Mains voltages	: 220 V AC, with service solution for 110, 127 and 240 V
Power consumption	: \leq 5 W

Cabinet

Dimensions (wxhxd)	: 320x54/60x247 mm approx.
--------------------	----------------------------



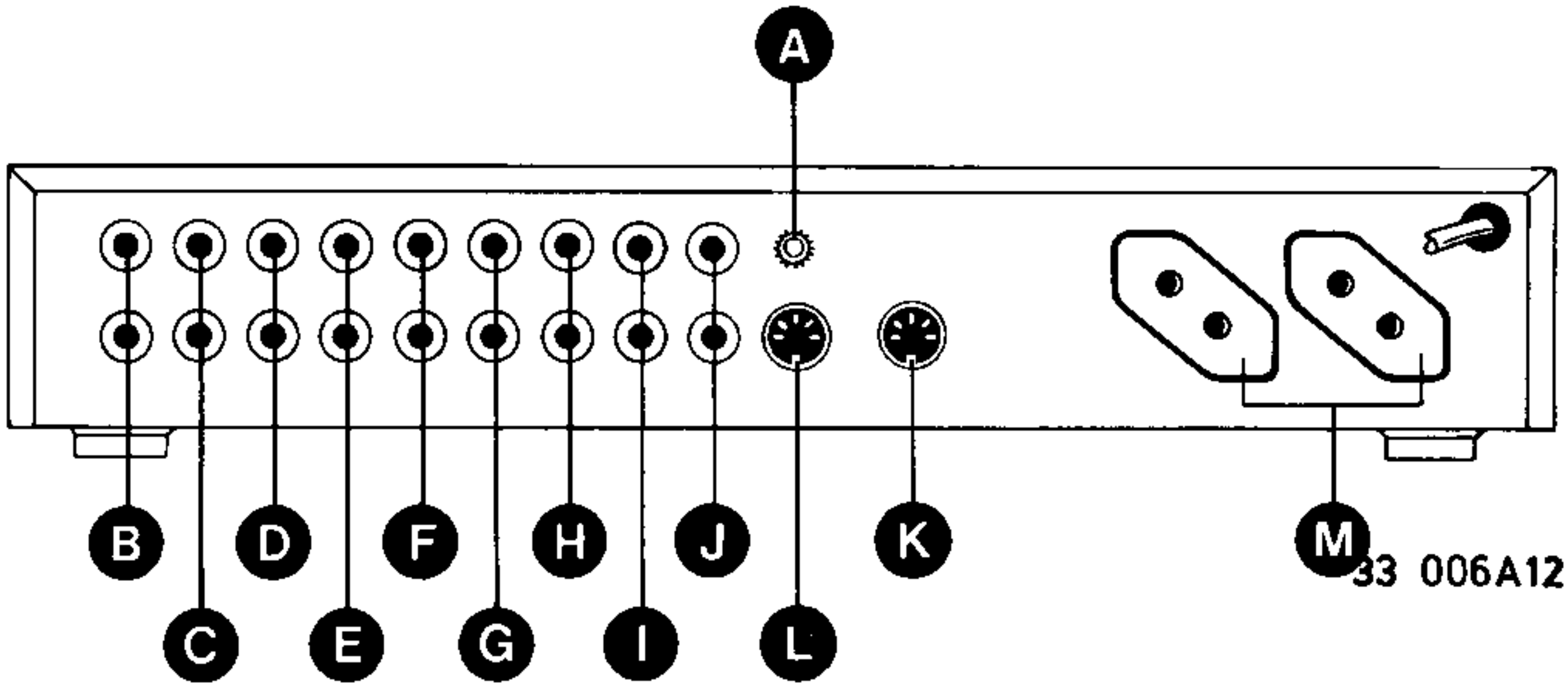
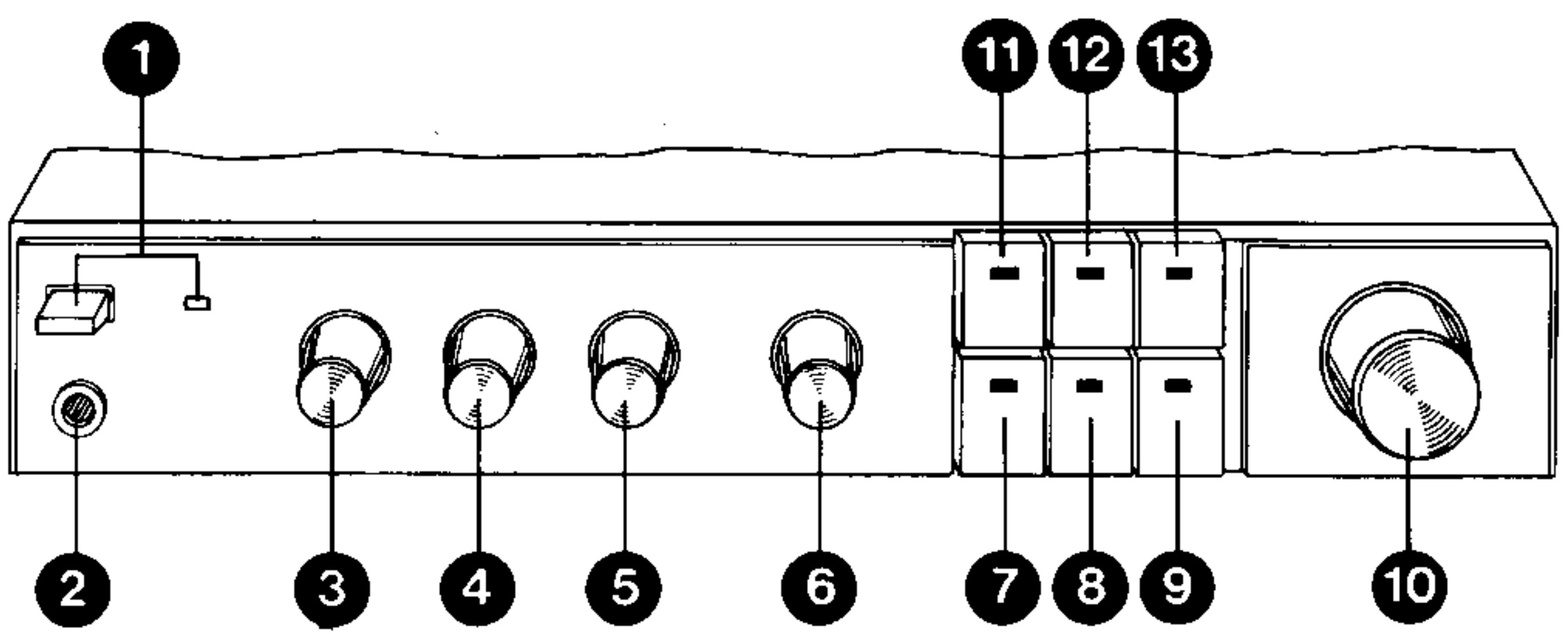

33 006A12

CONNECTIONS AND CONTROLS

1		„ON/OFF”	SK4	A		„Earth terminal”
2		„Headphone”		B		„Tape 1 out”
3		„Bass”	3531	C		„Tape 1 in”
4		„Treble”	3539	D		„Tuner in”
5		„Balance”	3510	E		„Aux/TV in”
6		„Source selector”	SK41	F		„CD in”
7		„Loudness”	SK42	G		„Phono in”
8		„Mono”	SK43	H		„Tape 2 in”
9		„Tape 1 monitor”	SK44	I		„Tape 2 out”
10		„volume”	3504	J		„PA out”
11		„Mute”	SK1	K		„MFB out”
12		„Cut high”	SK2	L		„MFB out”
13		„Cut low”	SK3	M		„AC outlets”

BU2/BU1

CS 90 543

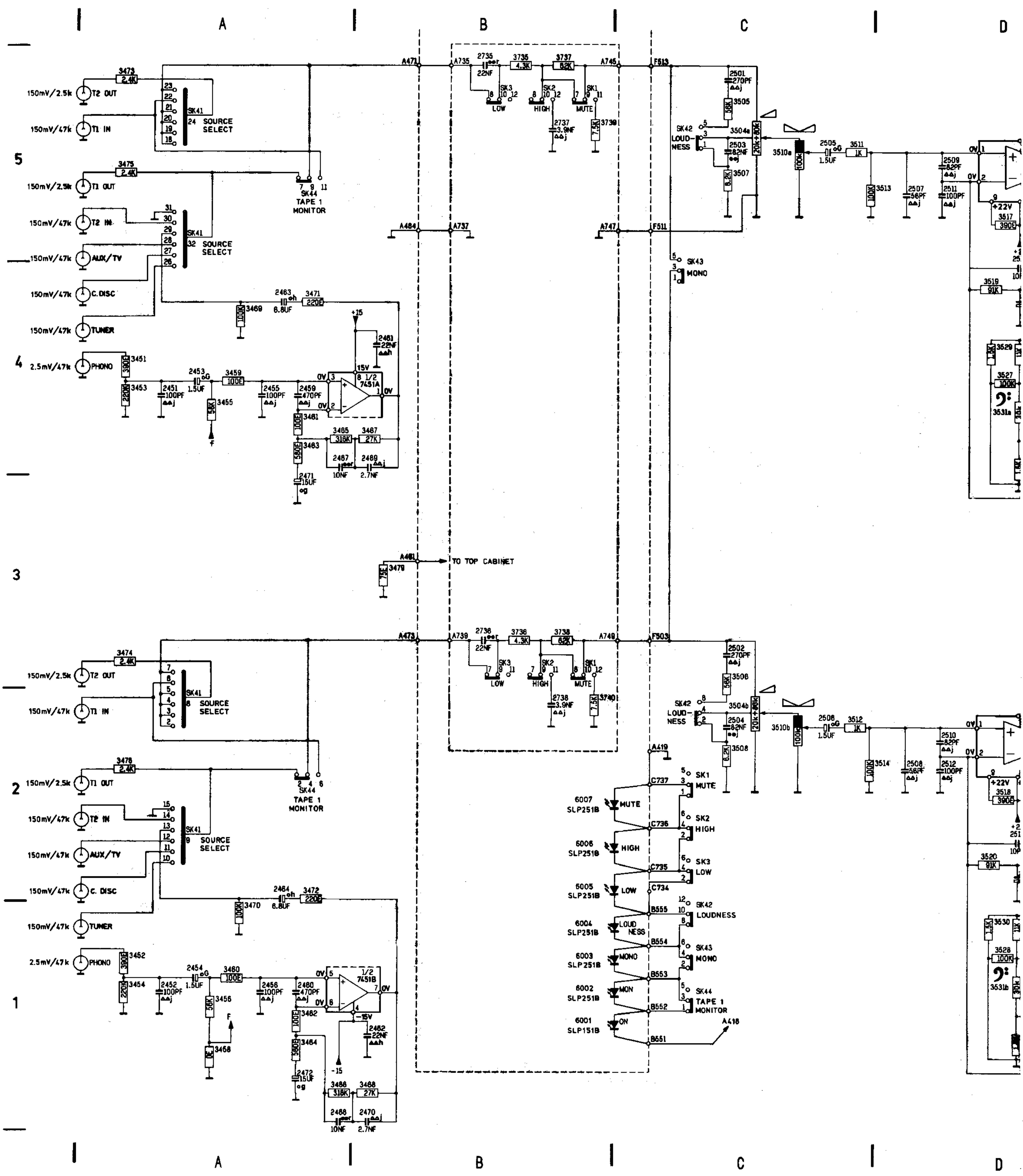

1003 G01	2409 G01	2451 A04	2456 A01	2463 A04	2470 B01	2503 C05	2508 D02	2513 D05	2518 D02	2523 D04	2528 E01	2541 E01	2653 E05	2725 F05	273
2401 G01	2410 G01	2452 A01	2459 A04	2464 A02	2471 A04	2504 C02	2509 D05	2514 D02	2519 D05	2524 D01	2529 E04	2545 E05	2654 E02	2726 F02	273
2402 G01	2420 G01	2453 A04	2460 A01	2467 A04	2472 A01	2505 C05	2510 D02	2515 D05	2520 D02	2525 D04	2530 E01	2546 E03	2655 E05	2729 F03	273
2404 G01	2426 F01	2454 A01	2461 B04	2468 A01	2501 C05	2506 C02	2511 D05	2516 D02	2521 D04	2526 D01	2531 D04	2541 E01	2656 E03	2730 F03	340
2408 G01	2427 F01	2455 A04	2462 B01	2469 B04	2502 C03	2507 D05	2512 D02	2517 D05	2522 D02	2527 E04	2532 D01	2542 E02	2657 F01	2735 B05	340
3531B D01	3537 E04	3542 E01	3653 E05	3687 G04	3726 F02	3733 F04	3738 B03	3748 F05	6003 B01	6401 G01	6411 F01	6726 F03	7451A B04	7652 E02	772
3533 D04	3538 E01	3621 F03	3654 E03	3688 G03	3727 F05	3734 E03	3739 B05	3749 F03	6004 B01	6404 F01	6412 E01	6727 F05	7451B B01	7725 F05	773
3534 D01	3539A E04	3622 F03	3655 E03	3689 G04	3728 F02	3735 B05	3740 B02	5001 G01	6005 B02	6407 G01	6413 F01	6728 F02	7501 D05	7726 F02	773
3535 D04	3539B E01	3651 D05	3657 E03	3690 G03	3731 E03	3736 B03	3746 F04	6001 B01	6006 B02	6409 F01	6501 E01	7402 F01	7502 D02	7727 F04	BU
3536 D01	3541 E04	3652 D02	3684 G01	3725 F05	3732 F03	3737 B05	3747 F03	6002 B01	6007 B02	6410 F01	6725 F04	7403 F01	7651 E05	7728 F02	BU

0001	F 3	2462	E 3	3506	D 2	8512	B 2
0002	F 3	2463	E 3	3507	D 1	8513	B 2
0003	F 3	2464	F 3	3508	D 1	8514	C 2
0004	F 3	2467	E 3	3510	C 1	8515	C 2
0005	F 3	2468	F 3	3511	B 1	8516	B 2
0006	F 3	2469	E 3	3512	C 1	8551	C 2
0007	F 3	2470	F 3	3513	C 1	8552	C 2
0008	E 2	2471	E 4	3514	C 1	8553	C 1
0009	F 2	2472	F 4	3515	B 1	8554	C 1
0010	F 2	2501	D 2	3516	C 1	8555	C 1
0011	F 2	2502	D 1	3517	B 1	0621	A 2
0012	F 2	2503	D 2	3518	C 1	0622	A 2
0013	E 2	2504	D 1	3519	B 1	0623	A 2
0014	F 2	2505	C 1	3520	C 1	0624	A 2
0015	F 2	2506	C 1	3521	B 1	0625	A 2
0016	F 2	2507	B 1	3522	C 1	F503	F 1
0017	E 2	2508	C 1	3523	B 1	FS11	E 1
0018	F 2	2509	B 1	3524	C 1	FS13	F 1
0019	E 2	2510	C 1	3525	A 1		
0021	E 2	2511	B 1	3526	B 1		
0022	E 2	2512	C 1	3527	A 1		
0023	E 2	2513	B 1	3528	B 1		
0024	E 2	2514	C 1	3529	B 1		
0025	E 2	2515	B 1	3530	B 1		
0028	E 1	2516	C 1	3531	B 1		
0029	E 1	2517	B 2	3533	A 1		
0030	E 1	2518	C 1	3534	B 1		
0031	E 1	2519	B 2	3535	B 1		
0032	E 1	2520	C 1	3536	B 1		
0033	E 1	2521	B 1	3537	B 1		
0034	E 1	2522	C 1	3538	B 1		
0036	F 4	2523	A 1	3539	B 1		
0037	D 3	2524	B 1	3541	B 1		
0039	D 3	2525	A 1	3542	B 1		
0041	E 3	2526	B 1	3621	A 1		
0043	D 3	2527	B 1	3622	A 1		
0046	E 3	2528	B 1	3651	B 2		
0049	D 3	2529	B 1	3652	C 1		
0051	D 3	2530	C 1	3653	A 2		
0052	D 3	2531	B 1	3654	C 2		
0054	D 3	2532	B 1	3655	D 3		
0055	C 3	2541	C 1	3657	D 3		
0057	D 2	2651	B 2	3684	D 2		
0059	C 2	2652	C 2	3687	C 4		
0060	D 2	2653	B 2	3688	C 4		
0062	D 1	2654	C 2	3689	C 4		
0063	D 1	2655	B 2	3690	C 4		
0065	D 1	2656	C 2	6401	C 3		
0066	D 1	2677	D 2	6404	E 3		
0067	D 1	3404	E 3	6407	E 2		
0069	D 1	3405	E 3	6409	C 3		
0070	D 1	3413	C 3	6410	D 3		
0071	D 1	3414	D 2	6411	D 3		
0072	D 1	3415	E 2	6412	E 3		
0083	E 3	3416	D 3	6413	D 3		
0084	C 1	3417	E 3				
0085	B 1	3419	D 3				
0086	B 2	3422	E 2	6501	C 1		
0087	C 2	3430	C 4	7402	E 3		
0088	C 1	3431	C 4	7403	E 3		
0089	D 4	3432	D 4	7451	E 3		
0091	B 1	3451	E 4	7501	B 1		
0092	D 4	3452	F 4	7502	C 1		
0093	D 4	3453	E 4	7651	B 1		
0094	D 3	3454	F 4	7652	C 2		
0096	A 3	3455	E 4	A401	C 2		
0101	D 2	3456	E 4	A404	C 2		
0102	F 3	3458	E 4	A411	C 2		
0103	D 3	3459	F 3	A418	D 4		
0104	C 3	3460	F 4	A419	E 4		
0105	C 3	3461	E 4	A444	C 4		
1652	D 4	3462	F 4	A445	C 4		
2401	D 2	3463	E 4	A446	C 4		
2402	C 2	3464	F 4	A447	C 4		
2404	E 3	3465	E 3	A448	C 4		
2408	C 3	3466	F 3	A449	C 4		
2409	C 3	3467	E 3	A471	F 2		
2410	C 3	3468	F 3	A473	F 2		
2420	E 3	3469	F 3	A494	F 2		
2426	D 2	3470	F 3	A491	E 4		
2427	D 2	3471	E 3	A651	D 3		
2451	F 4	3472	F 3	A654	D 3		
2452	F 4	3473	E 2	A655	D 3		
2453	F 4	3474	E 2	A681	D 3		
2454	F 4	3475	F 4	A682	D 3		
2455	F 4	3476	F 4	A683	D 3		
2456	F 4	3479	E 4	A684	D 3		
2459	E 3			A685	D 3		
2460	F 3	3504	F 1	A686	D 3		
2461	E 3	3505	D 2	8511	B 2		

4
3
2
1

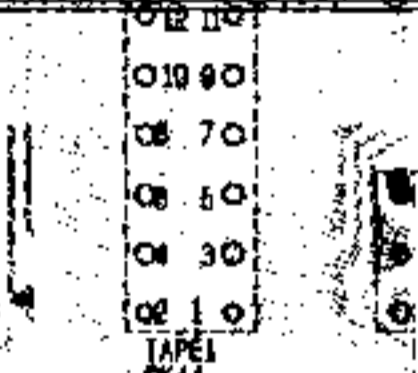
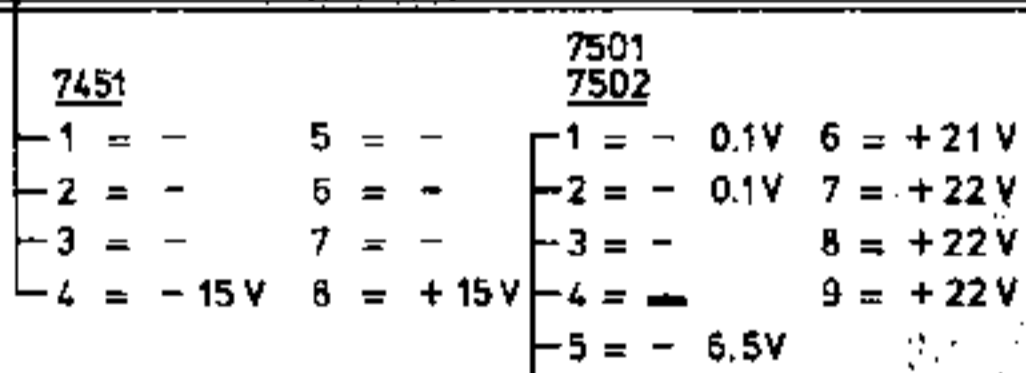
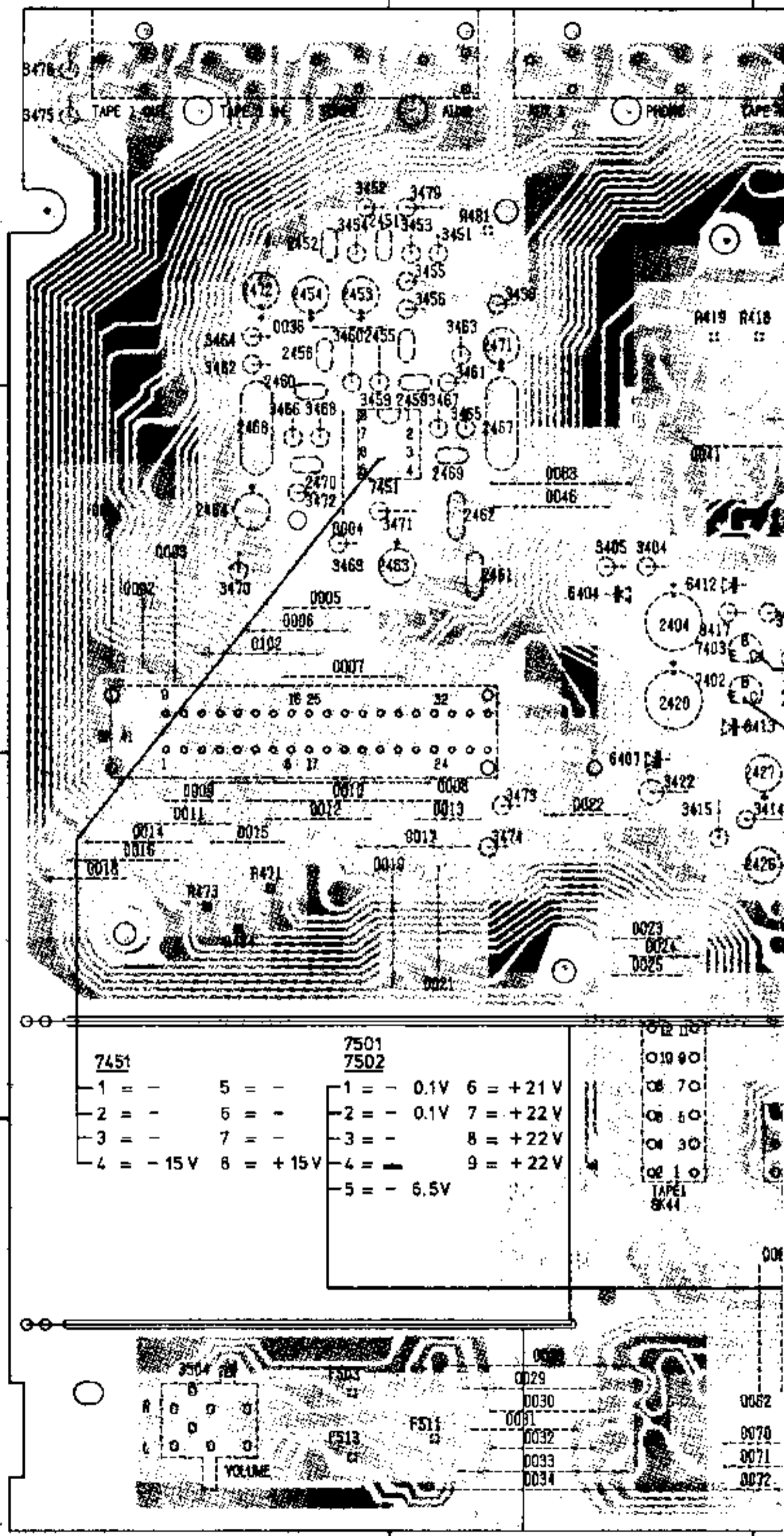

D

C

B

A

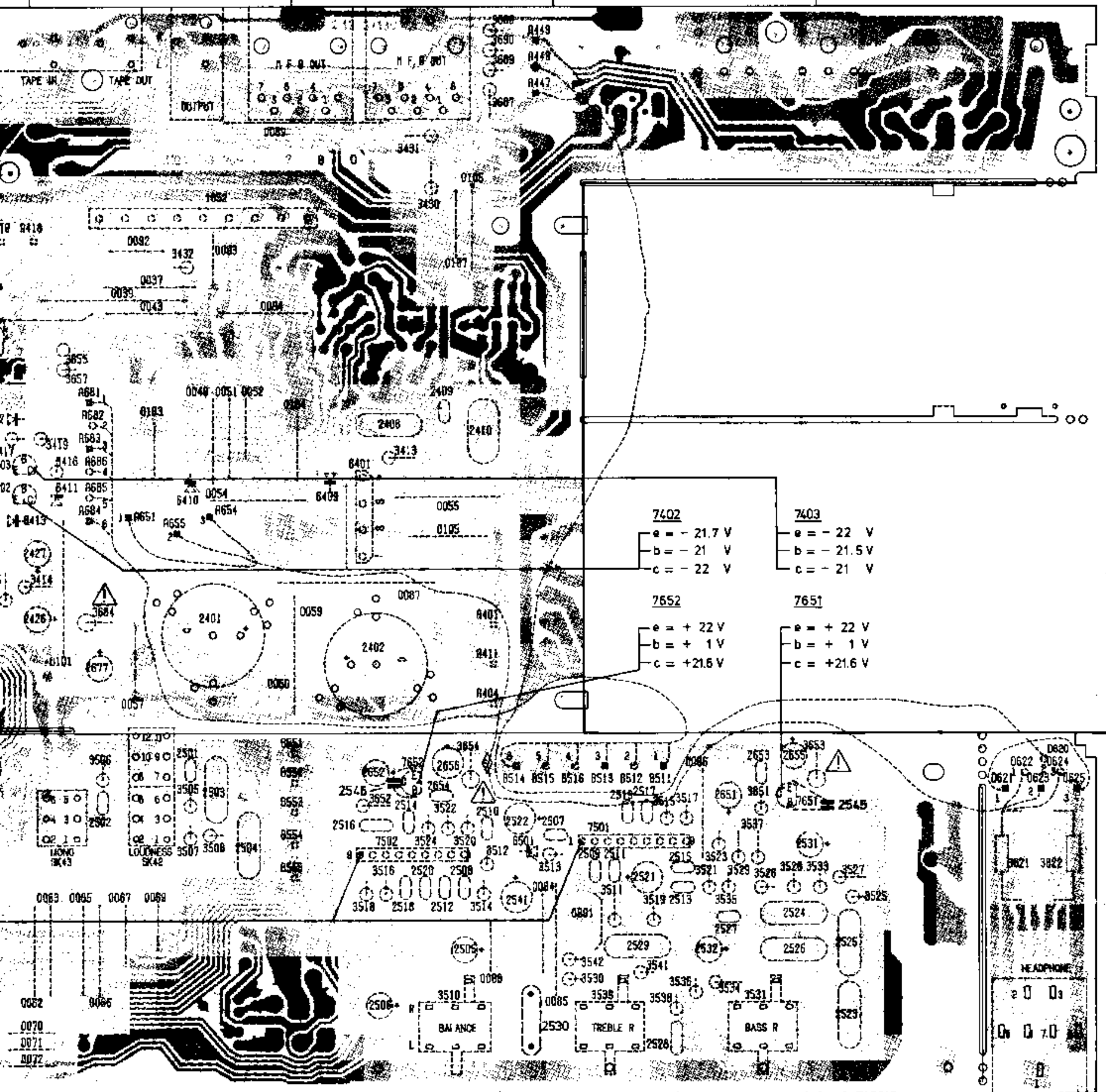

4

3

2

1

7402
 e = - 21.7 V
 b = - 21 V
 c = - 22 V

7403
 e = - 22 V
 b = - 21.5 V
 c = - 21 V

7652
 e = + 22 V
 b = + 1 V
 c = +21.6 V

7651
 e = + 22 V
 b = + 1 V
 c = +21.6 V

D

C

B

A

A

B

C

0001	F 3	2482	E 3	3506	D 2	8512	B 2
0002	F 3	2463	E 3	3507	D 1	8513	B 2
0003	F 3	2464	F 3	3508	D 1	8514	C 2
0004	F 3	2467	E 3	3510	C 1	8515	C 2
0005	F 3	2468	F 3	3511	B 1	8516	B 2
0006	F 3	2489	E 3	3512	C 1	8551	C 2
0007	F 3	2470	F 3	3513	C 1	8552	C 2
0008	E 2	2471	E 4	3514	C 1	8553	C 1
0009	F 2	2472	F 4	3515	B 1	8554	C 1
0010	F 2	2501	D 2	3516	C 1	8555	C 1
0011	F 2	2502	D 1	3517	B 1	0621	A 2
0012	F 2	2503	D 2	3518	C 1	0622	A 2
0013	E 2	2504	D 1	3519	B 1	0623	A 2
0014	F 2	2505	C 1	3520	C 1	0624	A 2
0015	F 2	2506	C 1	3521	B 1	0625	A 2
0016	F 2	2507	B 1	3522	C 1	F503	F 1
0017	E 2	2508	C 1	3523	B 1	F511	E 1
0018	F 2	2509	B 1	3524	C 1	F513	F 1
0019	E 2	2510	C 1	3525	A 1		
0021	E 2	2511	B 1	3526	B 1		
0022	F 2	2512	C 1	3527	A 1		
0023	E 2	2513	B 1	3528	A 1		
0024	E 2	2514	C 1	3529	B 1		
0025	E 2	2515	B 1	3530	B 1		
0026	E 1	2516	C 1	3531	B 1		
0029	E 1	2517	B 2	3533	A 1		
0030	E 1	2518	C 1	3534	B 1		
0031	E 1	2519	B 2	3535	B 1		
0032	E 1	2520	C 1	3536	B 1		
0033	E 1	2521	B 1	3537	B 1		
0034	E 1	2522	C 1	3538	B 1		
0036	F 4	2523	A 1	3539	B 1		
0037	D 3	2524	B 1	3541	B 1		
0039	D 3	2525	B 1	3542	B 1		
0041	E 3	2528	B 1	3621	A 1		
0043	D 3	2527	B 1	3622	A 1		
0046	E 3	2528	B 1	3651	B 2		
0049	D 3	2529	B 1	3652	C 1		
0051	D 3	2530	C 1	3653	A 2		
0052	D 3	2531	B 1	3654	C 2		
0054	D 3	2532	B 1	3655	D 3		
0055	C 3	2541	C 1	3657	D 3		
0057	D 2	2651	B 2	3684	D 2		
0059	C 2	2652	C 2	3687	C 4		
0060	D 2	2653	B 2	3688	C 4		
0062	D 1	2654	C 2	3689	C 4		
0063	D 1	2655	B 2	3690	C 4		
0065	D 1	2656	C 2	6401	C 3		
0066	D 1	2677	D 2	6404	E 3		
0067	D 1	3404	E 3	6407	E 2		
0069	D 1	3405	E 3	6409	C 3		
0070	D 1	3413	C 3	6410	D 3		
0071	D 1	3414	D 2	6411	D 3		
0072	D 1	3415	E 2	6412	E 3		
0083	E 3	3416	D 3	6413	D 3		
0084	C 1	3417	E 3				
0085	B 1	3419	D 3				
0086	B 2	3422	E 2	6501	C 1		
0087	C 2	3430	C 4	7402	E 3		
0088	C 1	3431	C 4	7403	E 3		
0089	D 4	3432	D 4	7451	E 3		
0091	B 1	3451	E 4	7501	B 1		
0092	D 4	3452	F 4	7502	C 1		
0093	D 4	3453	E 4	7651	B 1		
0094	D 3	3454	F 4	7652	C 2		
0096	A 3	3455	E 4	R401	C 2		
0101	D 2	3456	E 4	R404	C 2		
0102	F 3	3458	E 4	R411	C 2		
0103	D 3	3459	F 3	R410	D 4		
0104	C 3	3460	F 4	R419	E 4		
0105	C 3	3461	E 4	R444	C 4		
1852	D 4	3462	F 4	R445	C 4		
2401	D 2	3463	E 4	R446	C 4		
2402	C 2	3464	F 4	R447	C 4		
2404	E 3	3465	E 3	R448	C 4		
2408	C 3	3466	F 3	R449	C 4		
2409	C 3	3467	E 3	R471	F 2		
2410	C 3	3468	F 3	R473	F 2		
2420	E 3	3469	F 3	R484	F 2		
2426	D 2	3470	F 3	R491	E 4		
2427	D 2	3471	E 3	R651	D 3		
2451	F 4	3472	F 3	R654	D 3		
2452	F 4	3473	E 2	R655	D 3		
2453	F 4	3474	E 2	R681	D 3		
2454	F 4	3475	F 4	R682	D 3		
2455	F 4	3476	F 4	R683	D 3		
2456	F 4	3479	E 4	R684	D 3		
2459	E 3			R685	D 3		
2467	F 3	3504	F 1	R686	D 3		
2461	E 3	3505	D 2	8511	B 2		

4

3

2

1

D 18

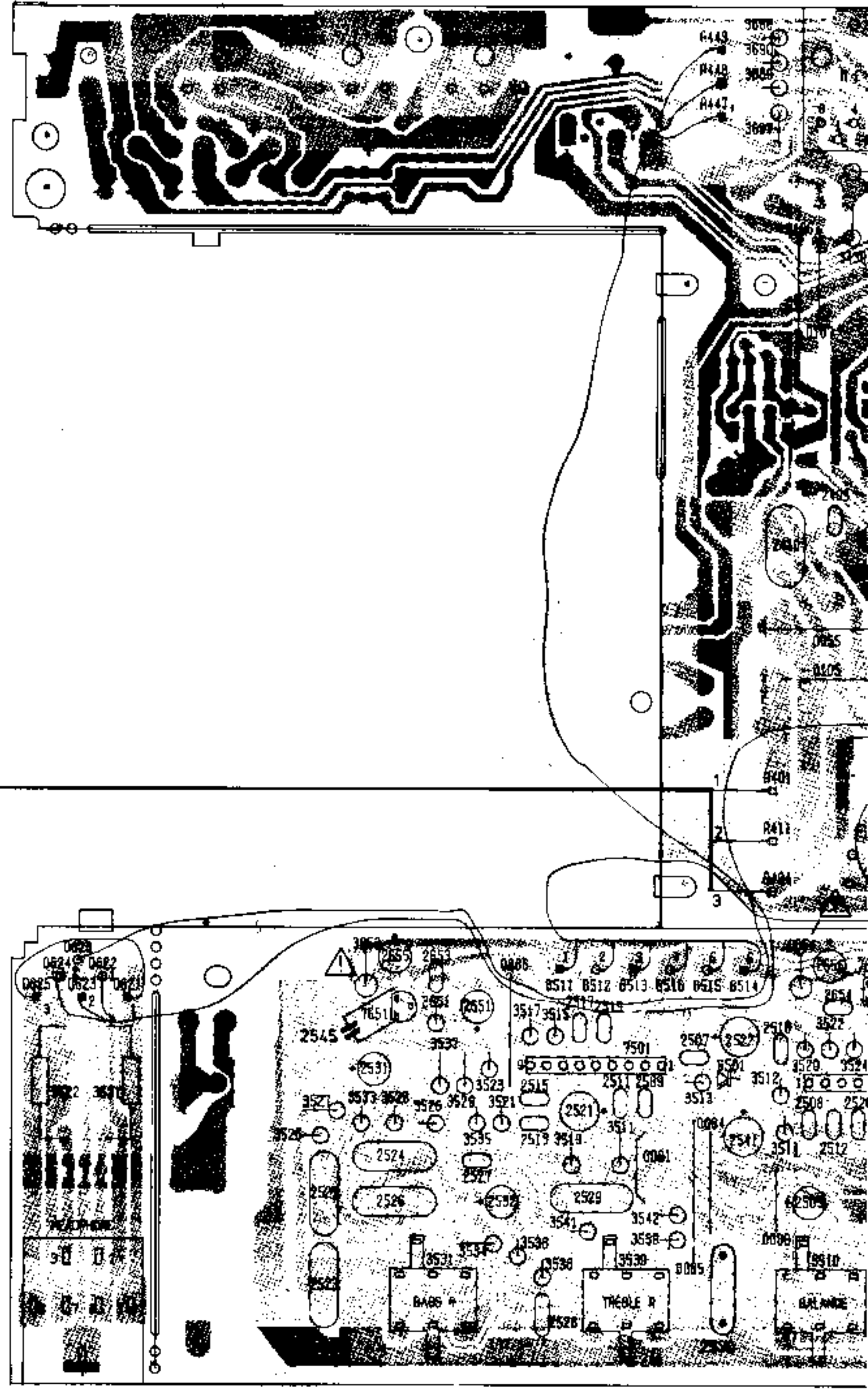

A

B

C

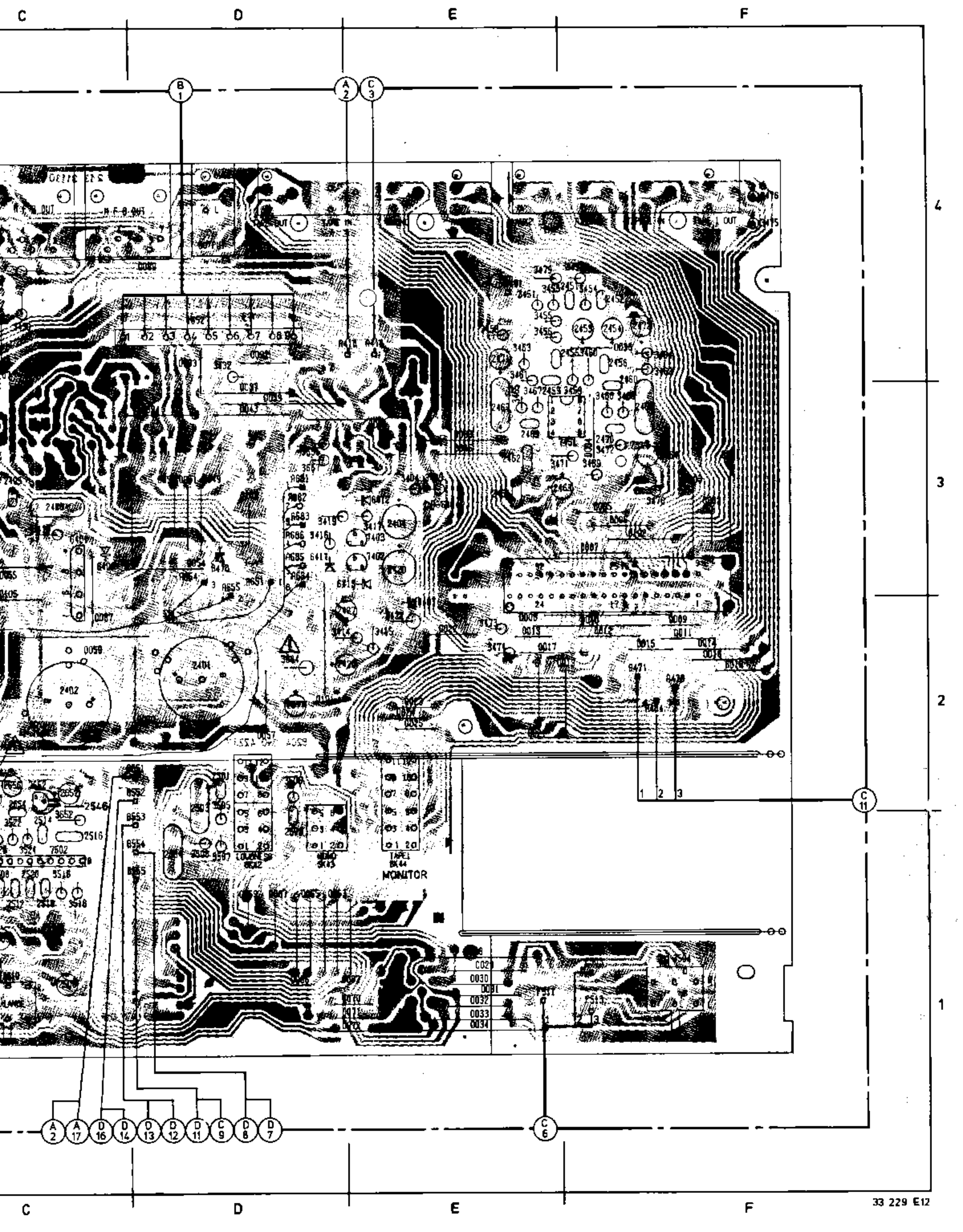

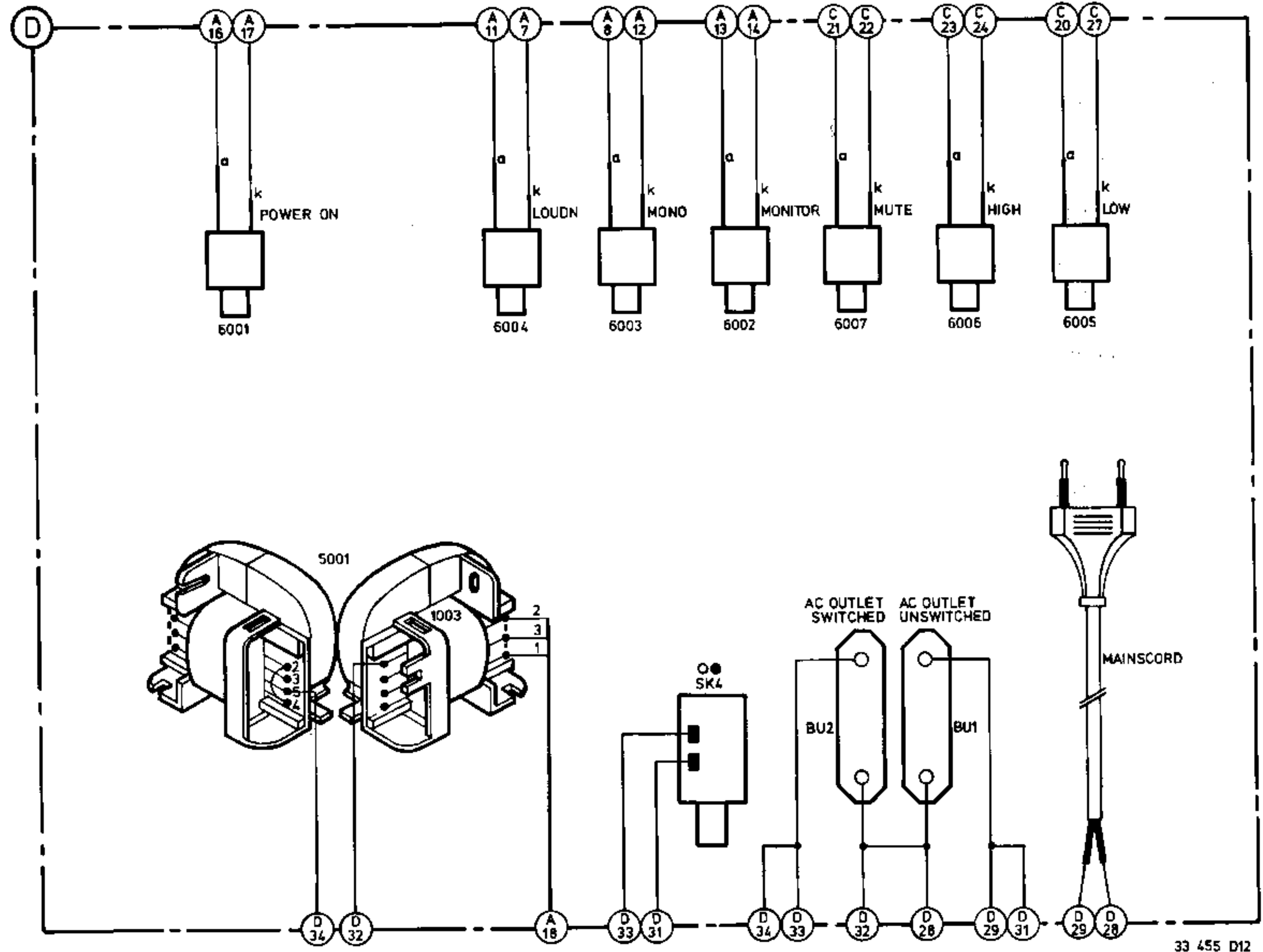
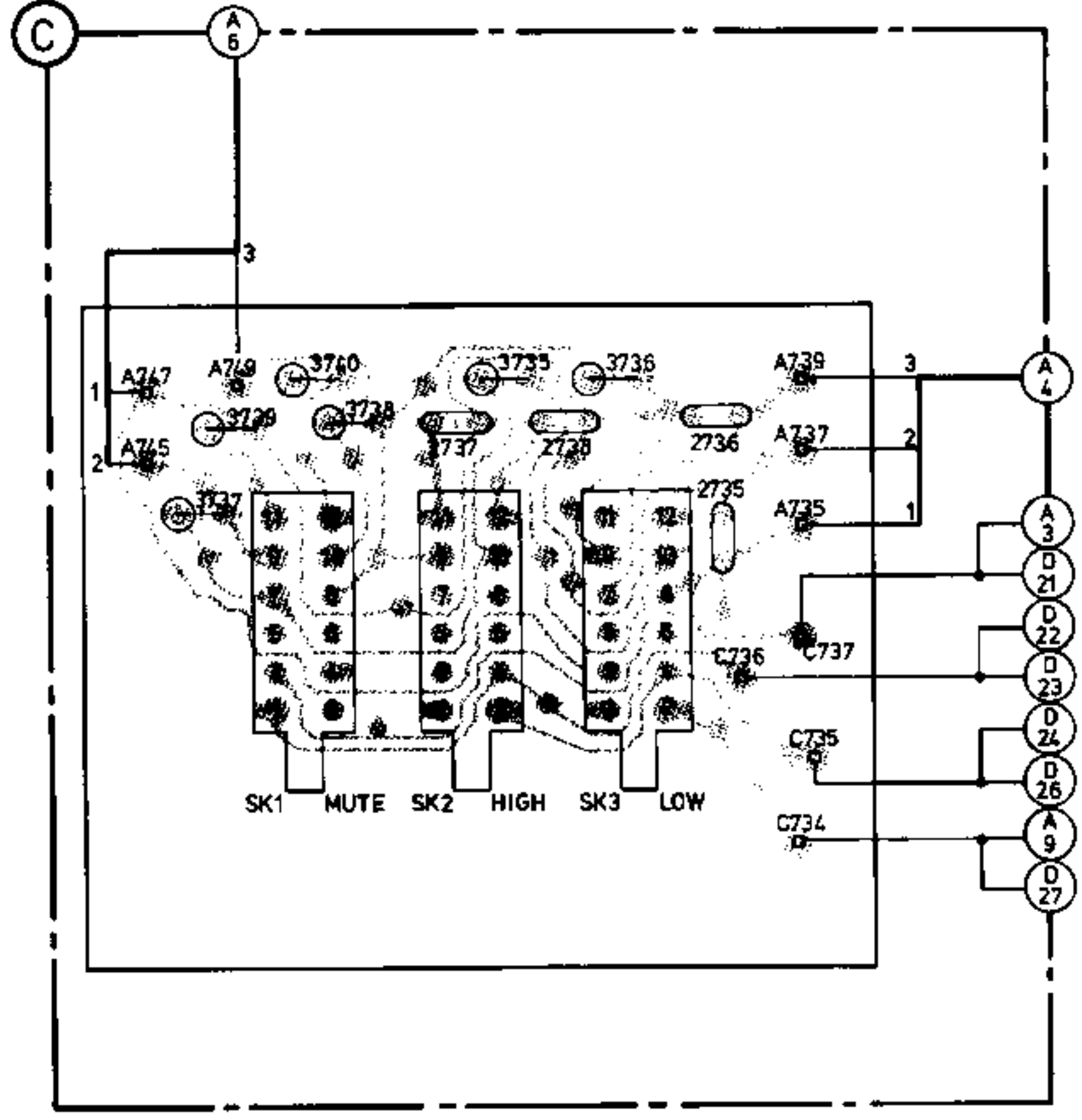
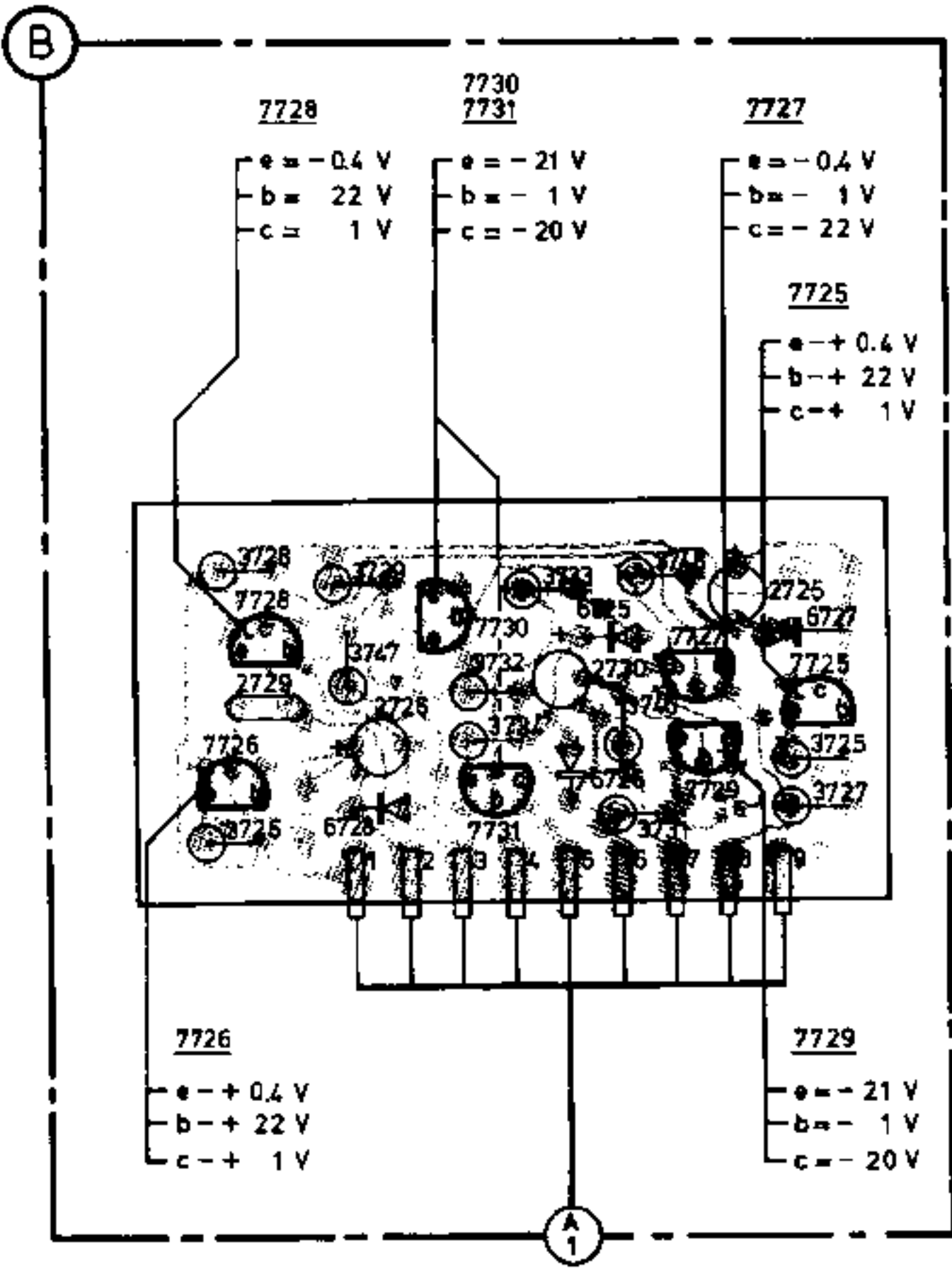

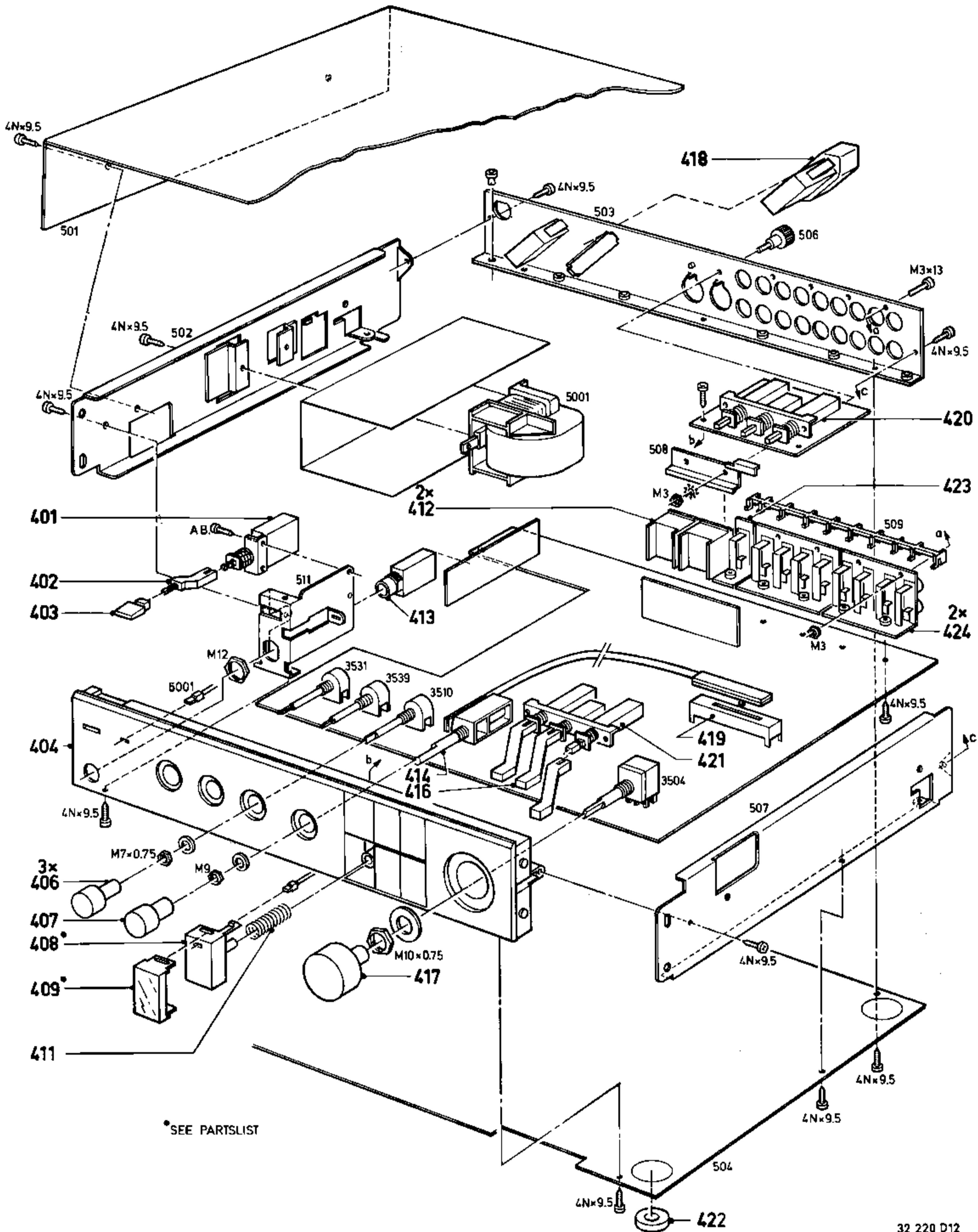







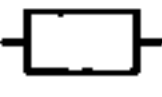







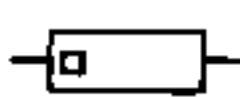



*SEE PARTSLIST

32 220 D12

401	4822 276 10807	408 High	4822 410 30317	418	4822 267 30499
402	4822 535 70774	408 Low	4822 410 30318	419	4822 277 20847
403	4822 410 22934	409 Lower 3	4822 410 50148	420	4822 276 30307
404	4822 426 50607	409 Upper 3	4822 460 20478	421	4822 276 11206
406	4822 413 31141	411	4822 492 51526	422	4822 462 40416
407	4822 413 31142	412	4822 267 50362	423	4822 267 30318
408 Loudness	4822 410 22935	413	4822 267 30378	424	4822 267 50284
408 Mono	4822 410 22936	414	4822 321 30273		
408 Monitor	4822 410 22937	416	4822 535 70773		
408 Mute	4822 410 30316	417	4822 413 41142		

-Resistors- 			-Diodes- 		
3504	Potpack 2x (20+80)k	4822 102 30405	BAX14		4822 130 31719
3510	Potm. 2x100k	4822 102 30403	BZX79/C15		4822 130 34281
3531	Potm. 2x30k neg.	4822 102 30404	BZX79/C2V4		4822 130 31253
3539	Potm. 2x30k neg.	4822 102 30404	BZX79/C24		4822 130 34398
3653 Δ	SR37 39E	4822 111 30005	BZX79/C6V2		4822 130 34167
3654 Δ	SR37 39E	4822 111 30005	KBP02	Diode bridge	4822 130 32118
3684 Δ	NFR25 12E	4822 111 30511	SLP151B	LED red	4822 130 31476
3465-3466	Met. res. 316k 1%	5322 116 55268	SLP251B	LED green	4822 130 31402
			1N4148		4822 130 30621
-IC- 			-Transistors- 		
AN7060		4822 209 81436	BC337		4822 130 40855
IR-2E02		4822 209 80943	BC338-40		5322 130 44779
MJM45581		4822 209 81054	BC547C		4822 130 44503
			BC548C		4822 130 44196
			BC556		4822 130 40989
-Miscellaneous-			BC637		4822 130 41041
1003	Thermal fuse	4822 252 20007	BC638		4822 130 41087
5001	Transf. mains	4822 146 40335			

	Carbon film 0.2 W 70°C 5%		Ceramic plate Tuning ≤ 120 pF NP.0 2% Others -20/+80%	*a = 2,5 V b = 4 V c = 6,3 V d = 10 V e = 16 V f = 25 V g = 40 V h = 63 V i = 100 V l = 125 V m = 150 V n = 160 V q = 200 V r = 250 V s = 300 V t = 350 V u = 400 V v = 500 V w = 630 V x = 1000 V A = 1,6 V B = 6 V C = 12 V D = 15 V E = 20 V F = 35 V G = 50 V H = 75 V I = 80 V
	Carbon film 0.33 W 70°C 5%		Polyester flat foil 10%	
	Metal film 0.33 W 70°C 5%		Metalized polyester flat film 10%	
	Carbon film 0.5 W 70°C 5%		Polyester flat foil small size (Mylar) 10%	
	Carbon film 0.67 W 70°C 5%		Polystyrene film/foil 1%	
	Carbon film 1.15 W 70°C 5%		Tubular ceramic	
			Miniature single	
			Subminiature tantalum $\pm 20\%$	
 Chip component				

27 037A/C

GB

Safety regulations require that the set be restored to its original condition and that parts which are identical with those specified, be used.

NL

Veiligheidsbepalingen vereisen, dat het apparaat bij reparatie in zijn oorspronkelijke toestand wordt teruggebracht en dat onderdelen, identiek aan de gespecificeerde, worden toegepast.

I

Le norme di sicurezza esigono che l'apparecchio venga rimesso nelle condizioni originali e che siano utilizzati i pezzi di ricambio identici a quelli specificati.

F

Les normes de sécurité exigent que l'appareil soit remis à l'état d'origine et que soient utilisées les pièces de rechange identiques à celles spécifiées.

D

Bei jeder Reparatur sind die geltenden Sicherheitsvorschriften zu beachten. Der Originalzustand des Geräts darf nicht verändert werden; für Reparaturen sind Original-Ersatzteile zu verwenden.